

2500 SERIES CURTAINWALL FRAMING DETAILS

E11

- 2500 SERIES 2 1/2" (63.5 MM) WIDE THERMALLY IMPROVED CURTAIN WALL FRAMING SYSTEM CAN BE USED FOR VARIOUS APPLICATIONS, SUCH AS FULL CURTAIN WALL AND STOREFRONT FRAMING, OR HIGH PERFORMANCE PUNCHED WINDOWS AND HORIZONTAL STRIP WINDOWS.
- RANGE OF MULLION DEPTHS AVAILABLE: 2 7/8"(73MM), 3 5/8"(92MM) OR 5 1/4" (133MM) FOR OPTIMUM STRUCTURAL REQUIREMENTS COMBINED WITH A 3/4" (19MM) EXTERIOR SNAP CAP TO SUIT THE REQUIRED DESIGN PARAMETERS.
- FRAMING SYSTEM OFFERS PRESSURE EQUALIZED RAIN SCREEN CAPABILITIES WITH THE DRY/DRY GLAZING GASKET METHOD AND VENTED HORIZONTAL MULLION GLAZING POCKETS.
- FRAMING SYSTEM ALLOWS FOR EXTERIOR AND INTERIOR COLOUR COMBINATIONS.
- OFFERS A 2 1/2" SIGHT LINE AND IS TOTALLY COMPATIBLE WITH ALL DESA ENTRANCE DOOR PACKAGES, THERMALLY IMPROVED AND NON THERMALLY IMPROVED TYPE.
- SYSTEM ACCOMMODATES FOR BOTH SEALED UNIT AND SPANDREL GLAZING AND ALSO THE DESA 20 SERIES VENT INSERT WINDOW.

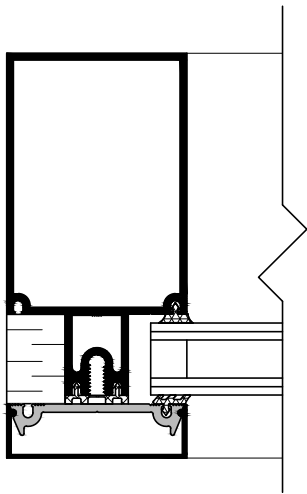
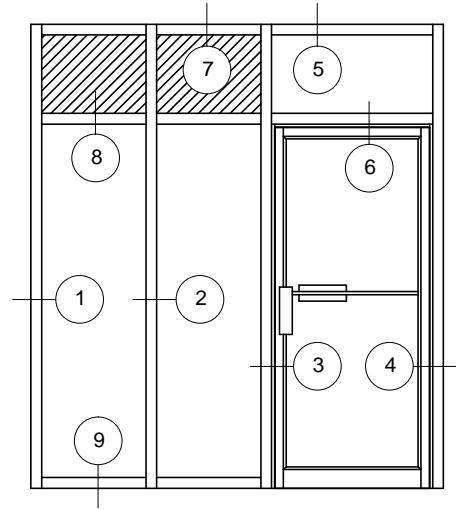

1

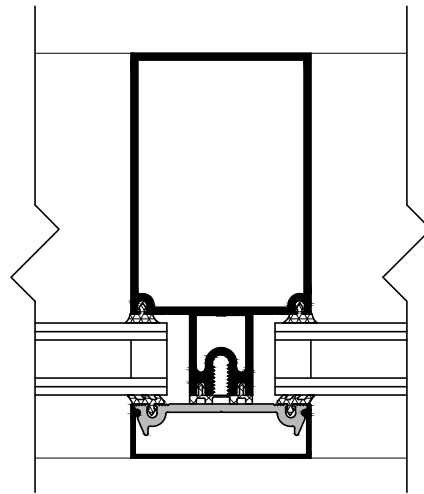

2

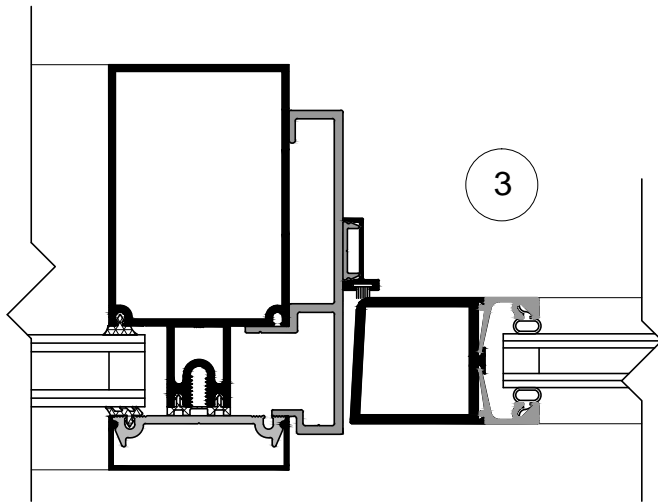

3

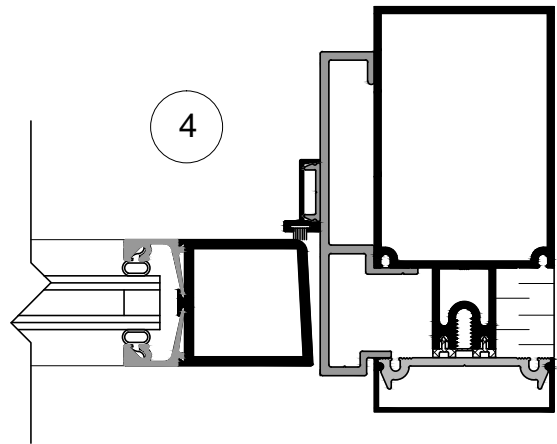

4

SCALE: 3/8" = 1"



providing innovative solutions that meet client needs.

2500 SERIES CURTAINWALL FRAMING DETAILS

E12

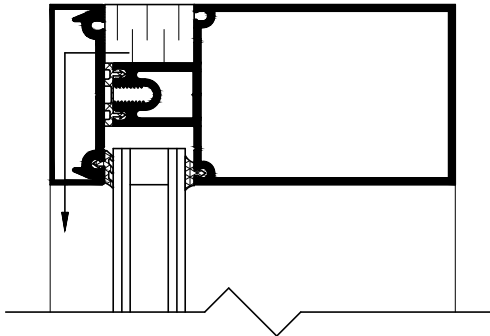

5

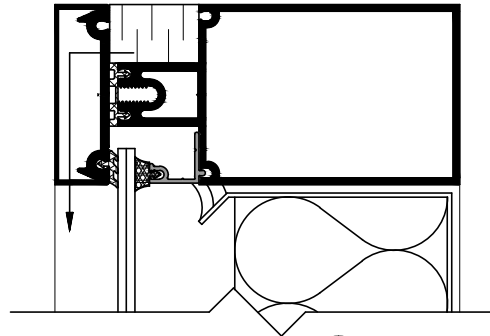

7

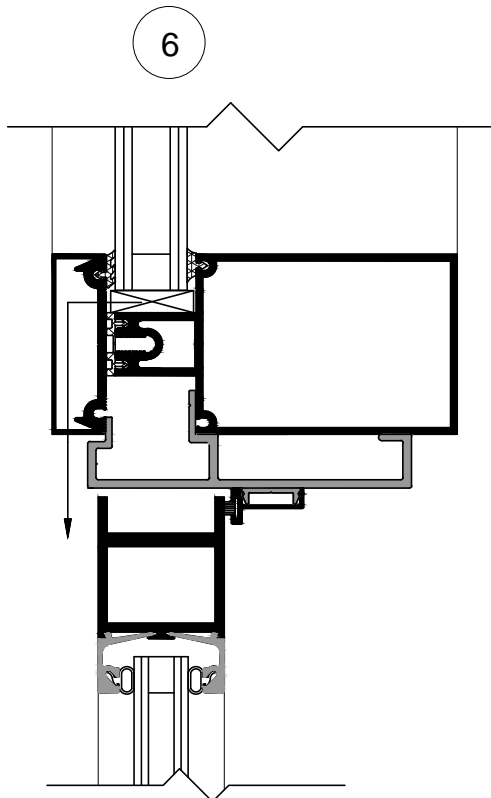

6

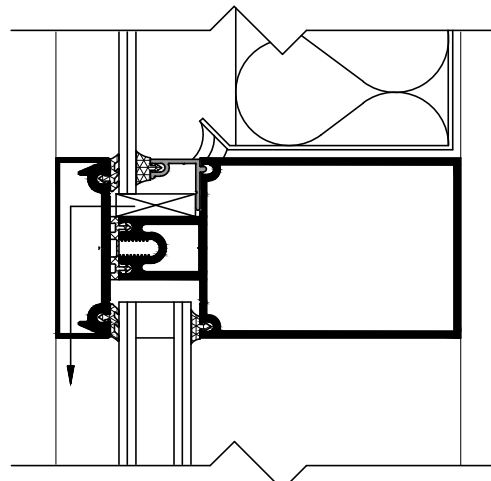

8

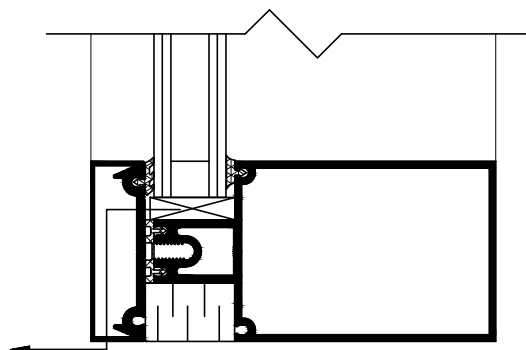

9

SCALE: 3/8" = 1"



providing innovative solutions that meet client needs.

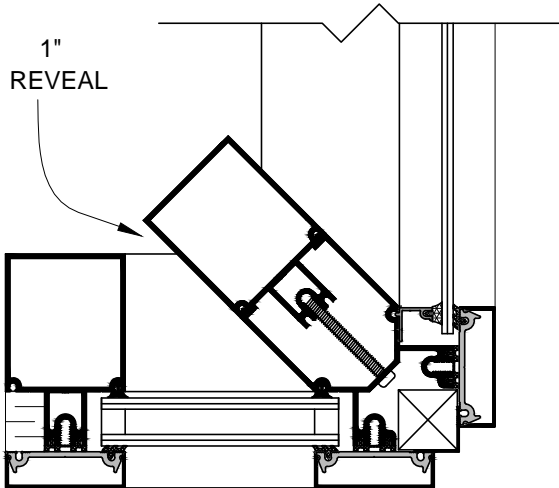

C2510
STANDARD CORNER

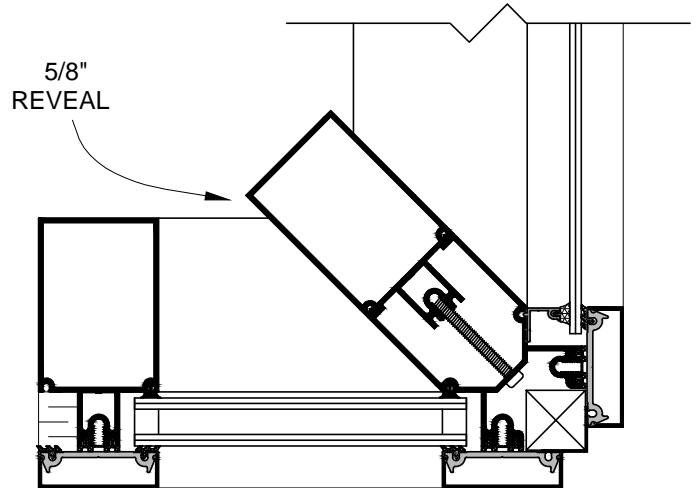

C2520
STANDARD CORNER

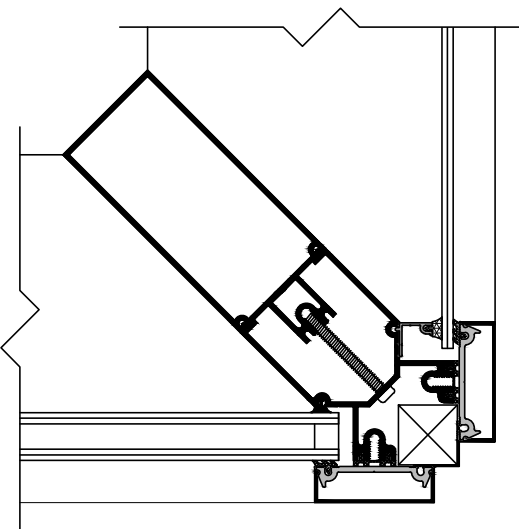

C2530
STANDARD CORNER

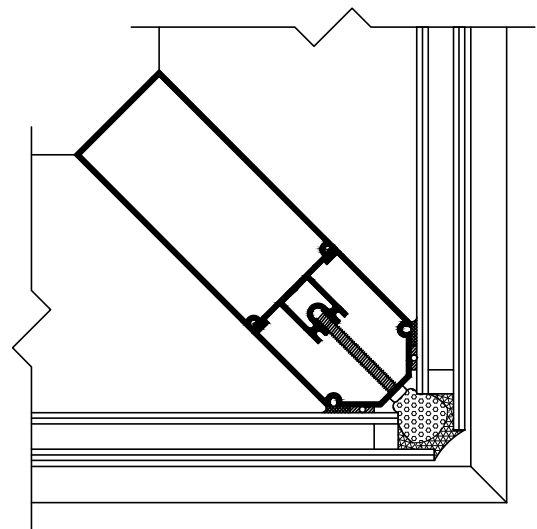

C2520
WITH NOSE REMOVED
FOR SILICONE GLAZING

SCALE: 1/4" = 1"



providing innovative solutions that meet client needs.

2500 SERIES SSG
STRUCTURAL SILICONE GLAZING

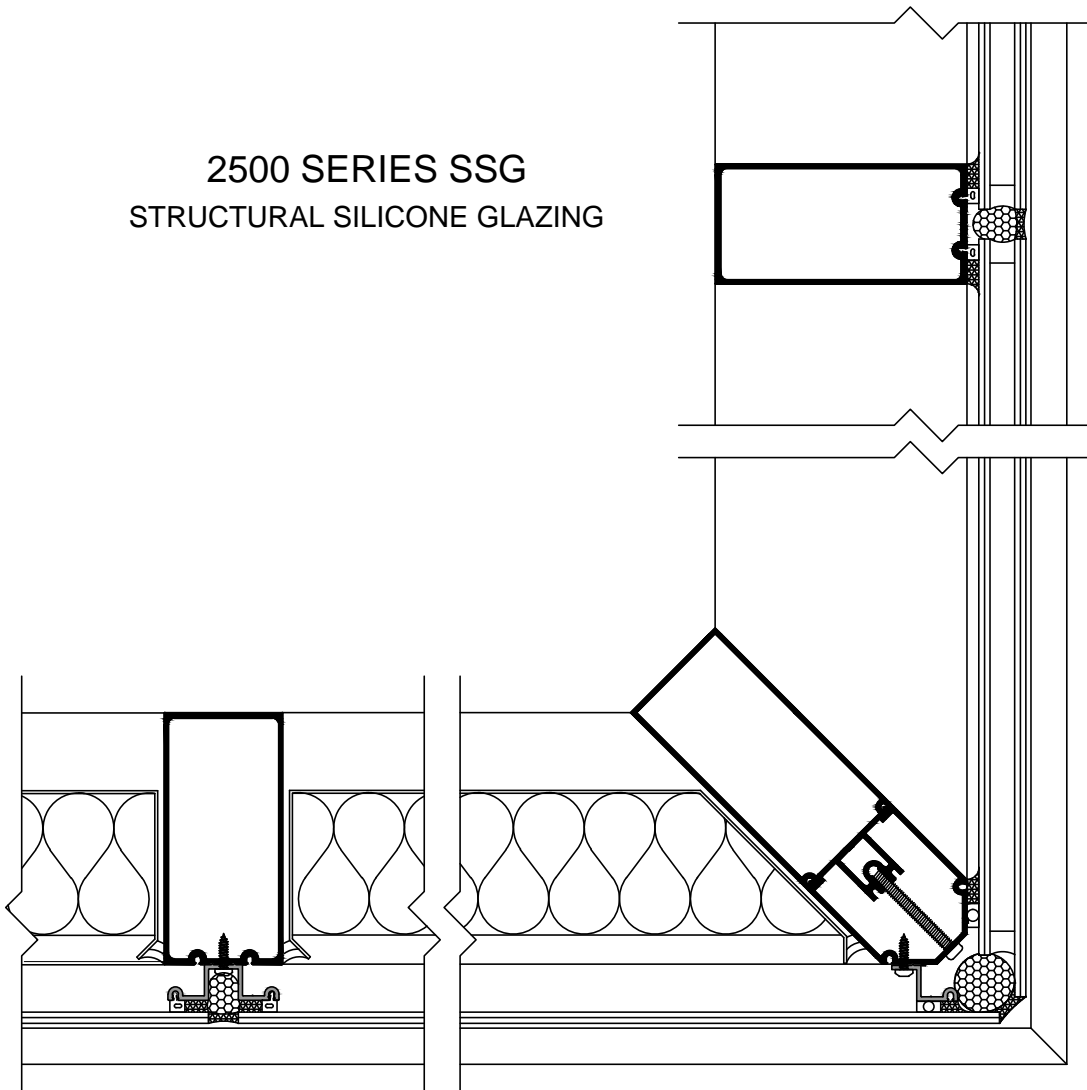

SCALE: 1/4" = 1"



providing innovative solutions that meet client needs.

2500 SERIES CURTAIN WALL FRAMING PARTS

E15

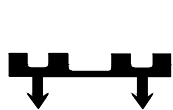
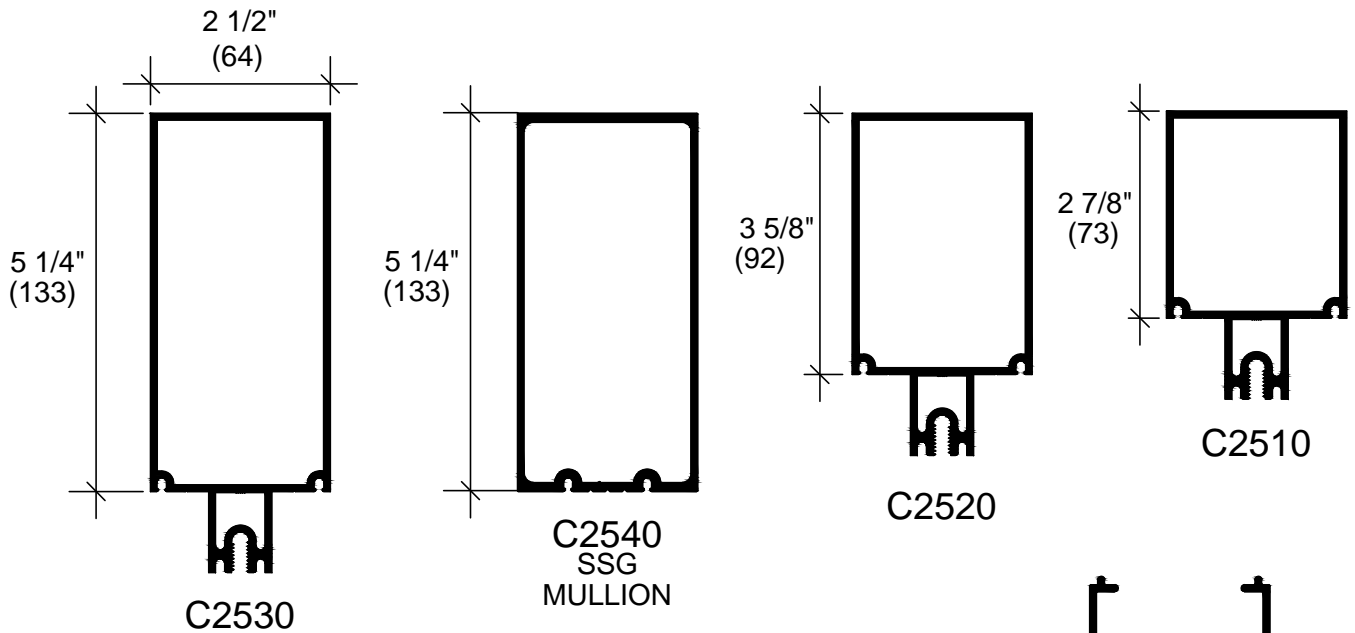

TB428
THERMAL
BARRIER

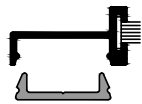

F2008
F2009
2 PIECE
DOOR STOP



C2550
SINGLE GLAZING
ADAPTER
SSG

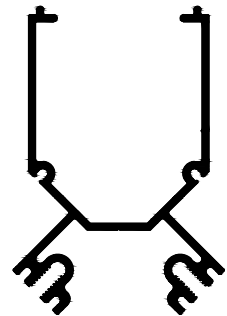

C2560
CORNER
ADAPTER



TB647
THERMAL
BARRIER
SSG



N208
INTERIOR
GASKET



D2570
SINGLE GLAZING
ADAPTER



SB21, SB22
2500 SERIES
SHEAR BLOCK



N233
EXTERIOR GASKET



N646
INTERIOR
GASKET
SSG



N648
SSG MULLION GASKET

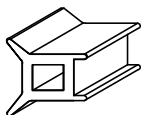

CP20
CORNER PLUG

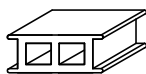

CP30
CORNER PLUG
SSG

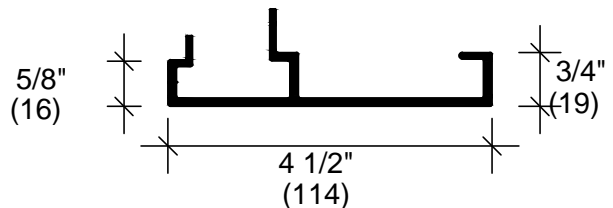

C2515
DOOR ADAPTER



2500 SERIES CURTAIN WALL FRAMING PARTS

E16

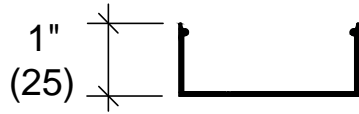

C2502
SNAP-ON
CAP

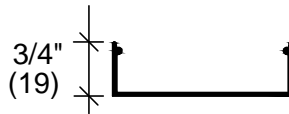

C2501
SNAP-ON
CAP



C2505
PRESSURE
PLATE

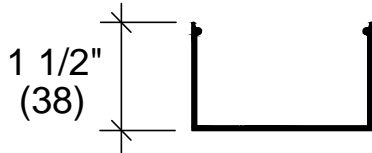

C2503
SNAP-ON
CAP

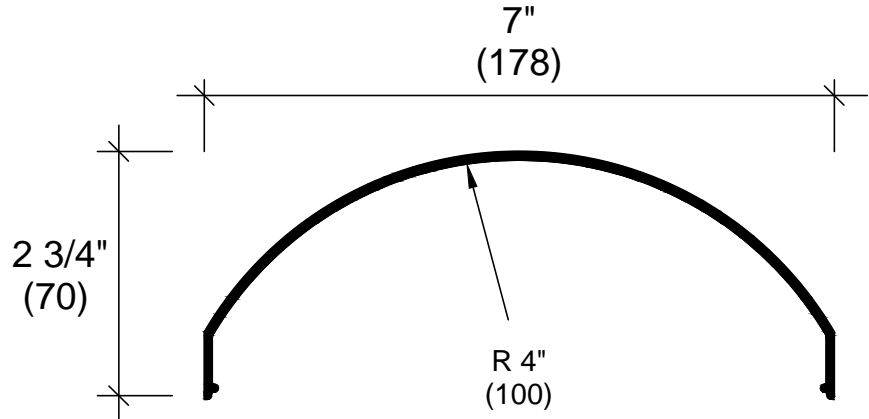

C2590
COLUMN
CAP

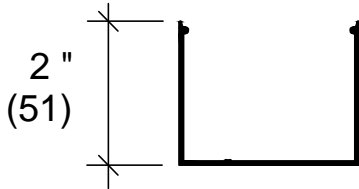

C2506
SNAP-ON
CAP

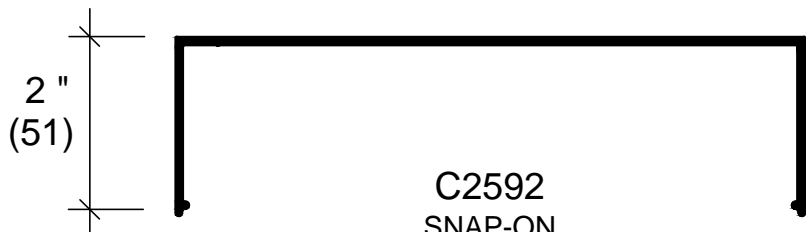

C2592
SNAP-ON
CAP

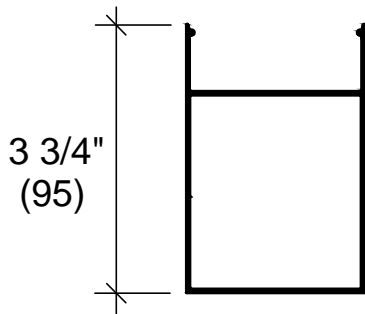

C2504
SNAP-ON
CAP



C2591
7"
PRESSURE
PLATE

SCALE: 3/8" = 1"



providing innovative solutions that meet client needs.